

# DARYL TYP 3 LWS-01

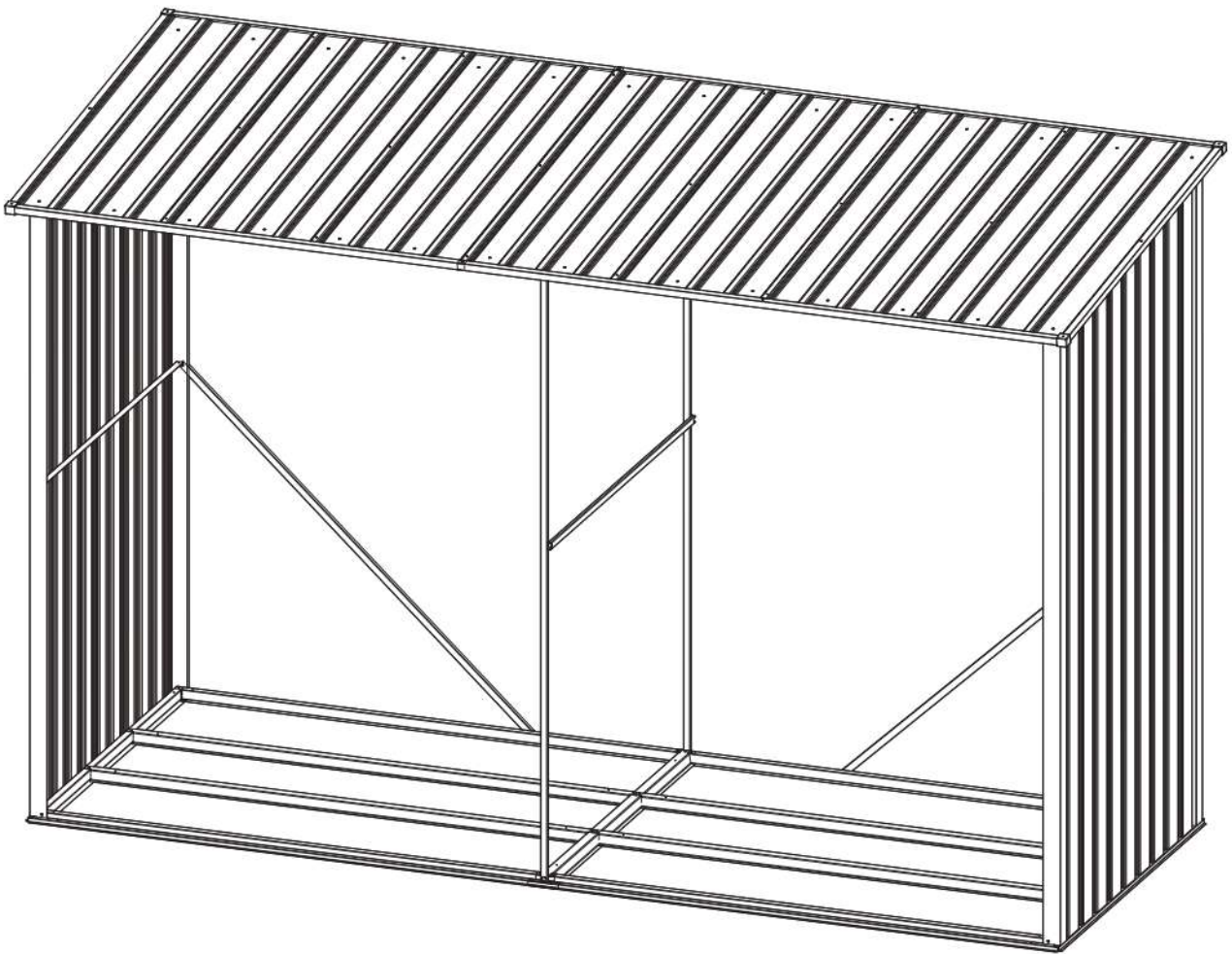

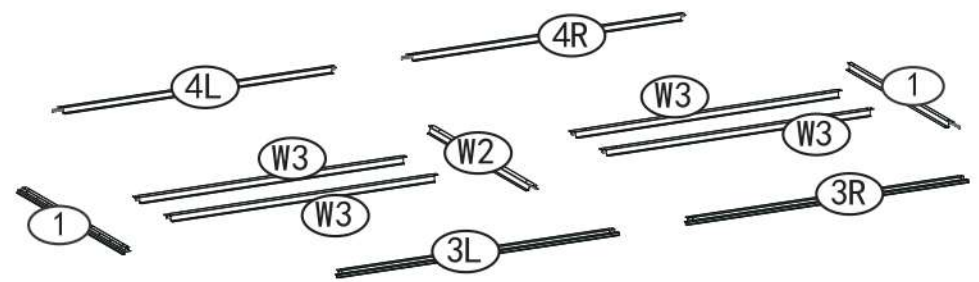

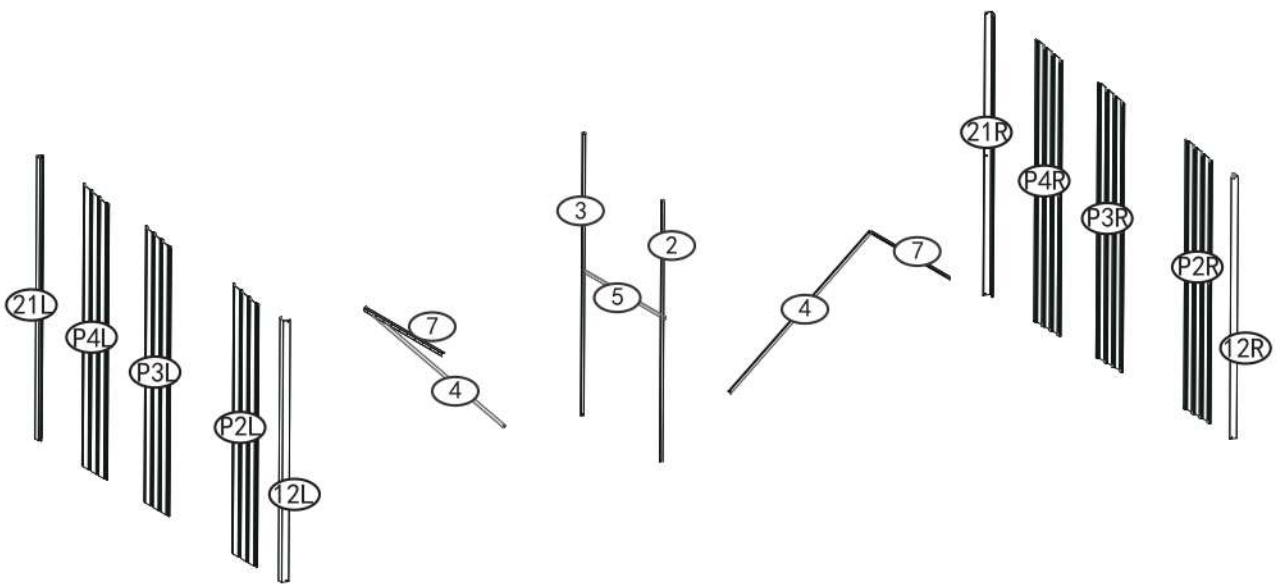

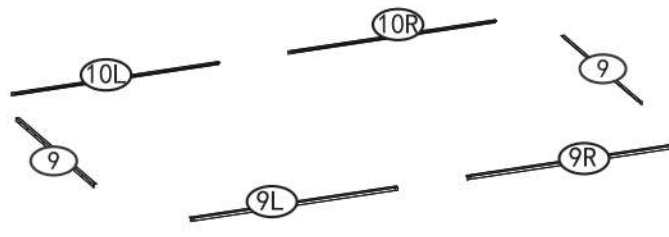
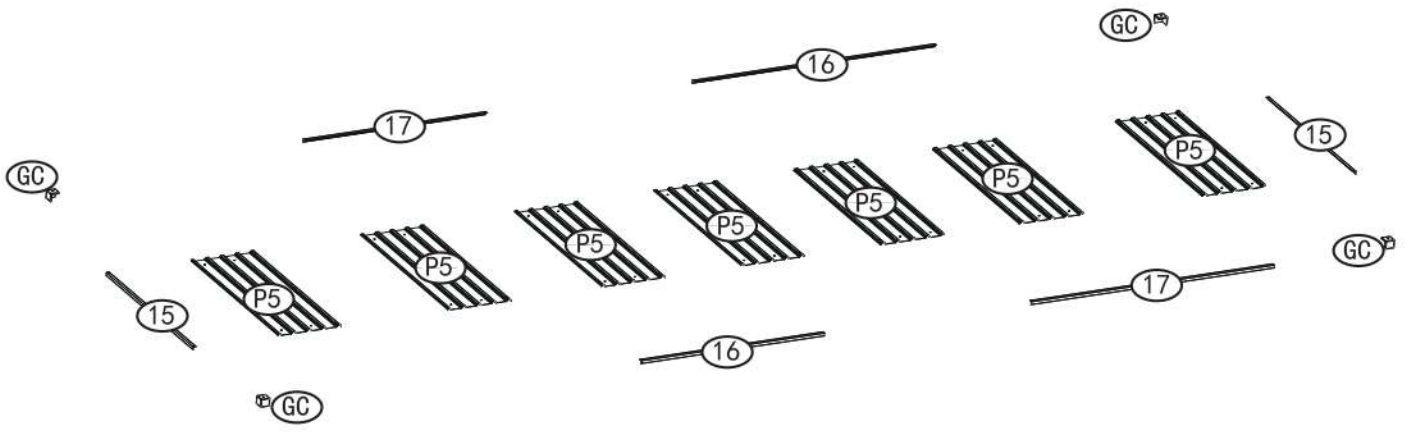
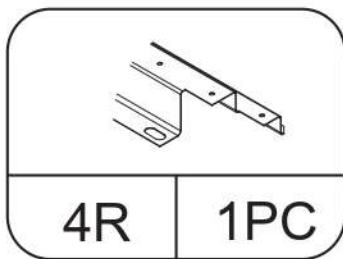
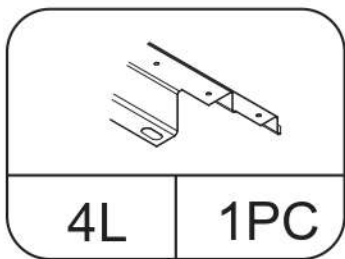
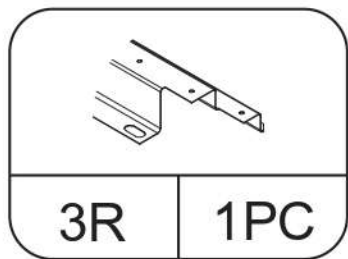
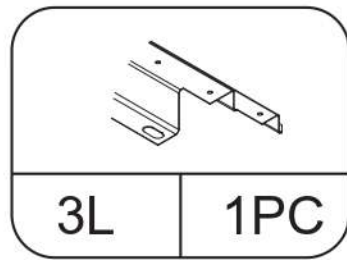
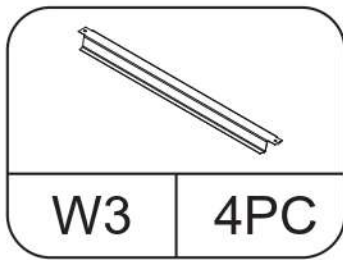
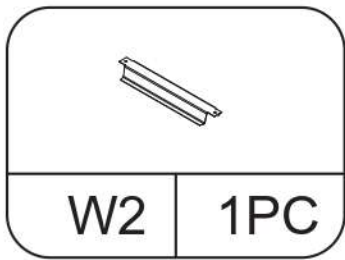
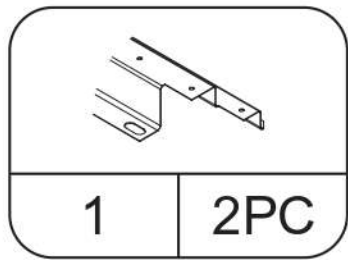

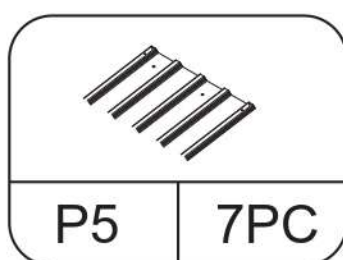
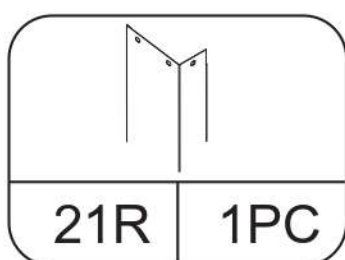
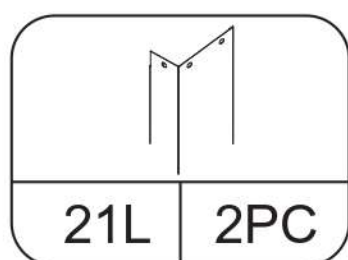
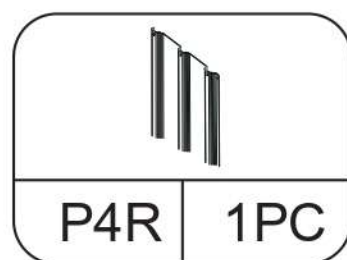
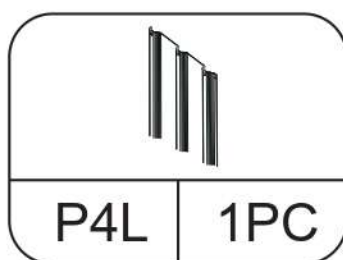
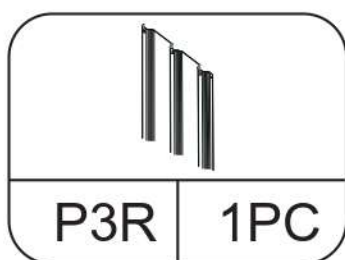
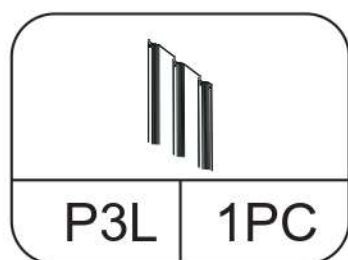
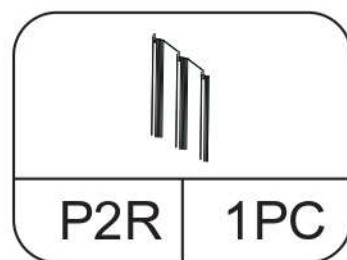
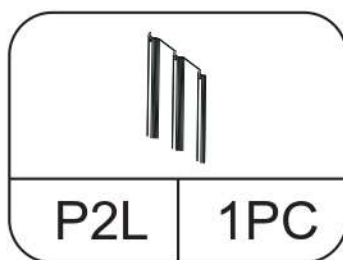
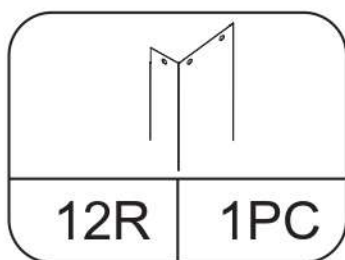
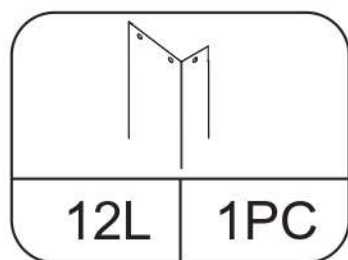
Fundații



Plăci



2	1PC
---	-----



3	1PC
---	-----

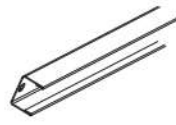

4	2PC
---	-----



5	1PC
---	-----

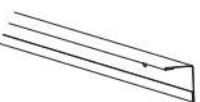

7	2PC
---	-----

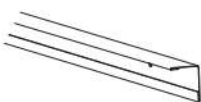

9	2PC
---	-----

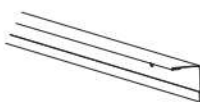

9L	1PC
----	-----

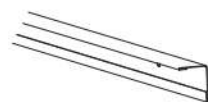

9R	1PC
----	-----



10L	1PC
-----	-----

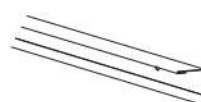

10R	1PC
-----	-----

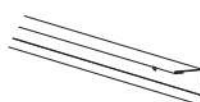

15	2PC
----	-----

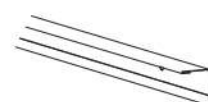

16	2PC
----	-----

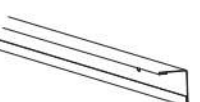

17	2PC
----	-----

Benzi

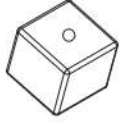

GC	4PC
----	-----

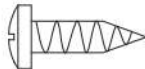

F1	128PC
----	-------



F2	2PC
----	-----

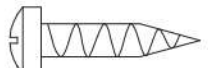

F3	4PC
----	-----



S1	72PC
----	------



S2	92PC
----	------

Standard

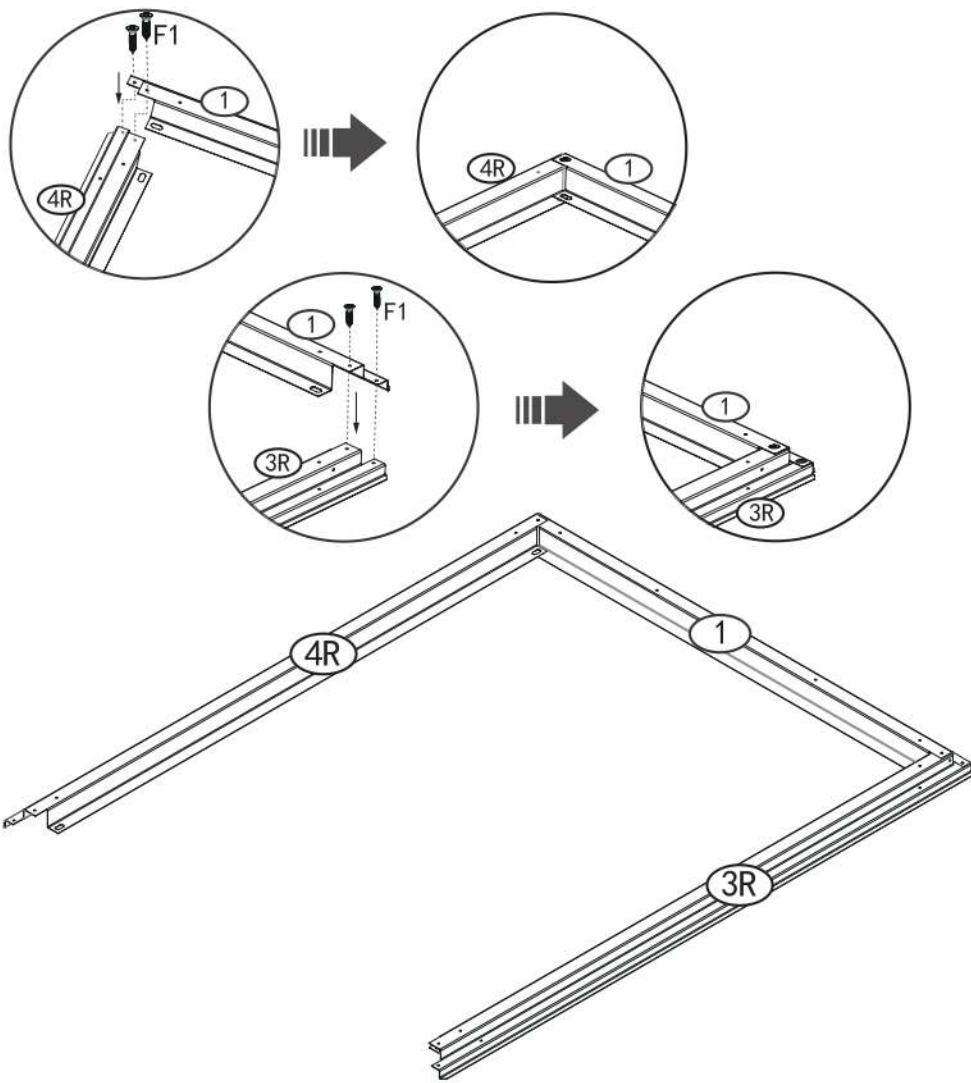

1	1PC

3R	1PC

4R	1PC

F1	4PC

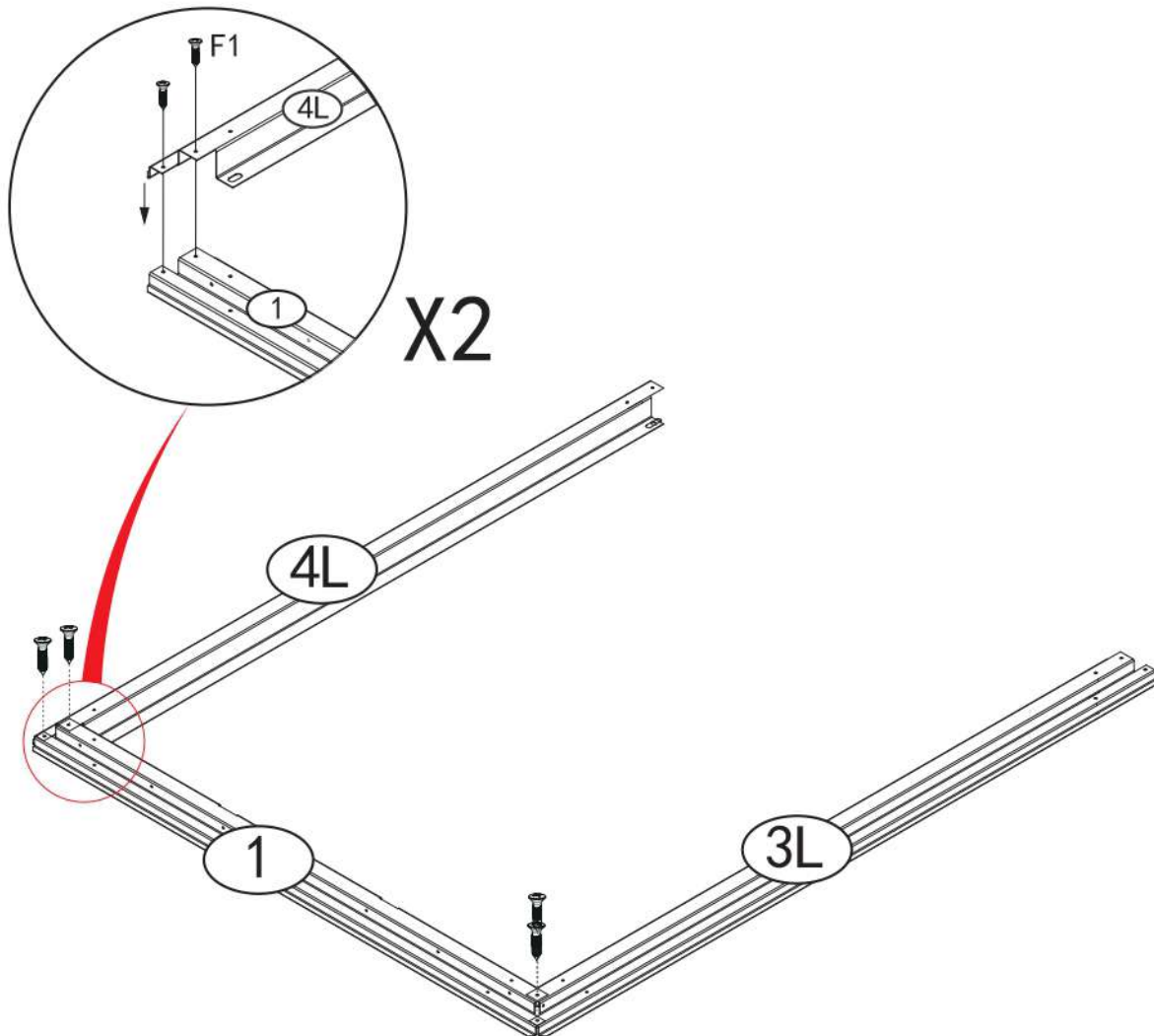

1	1PC

3L	1PC

4L	1PC

F1	4PC

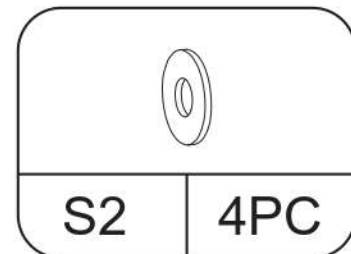
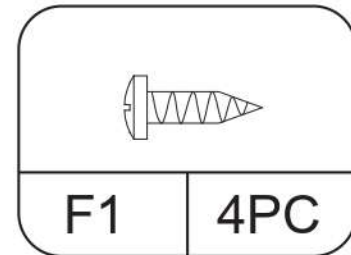
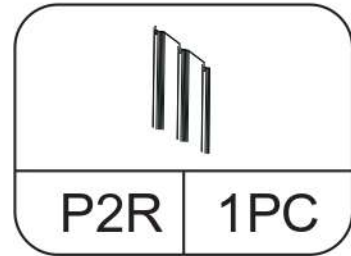
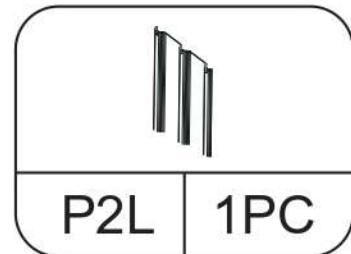
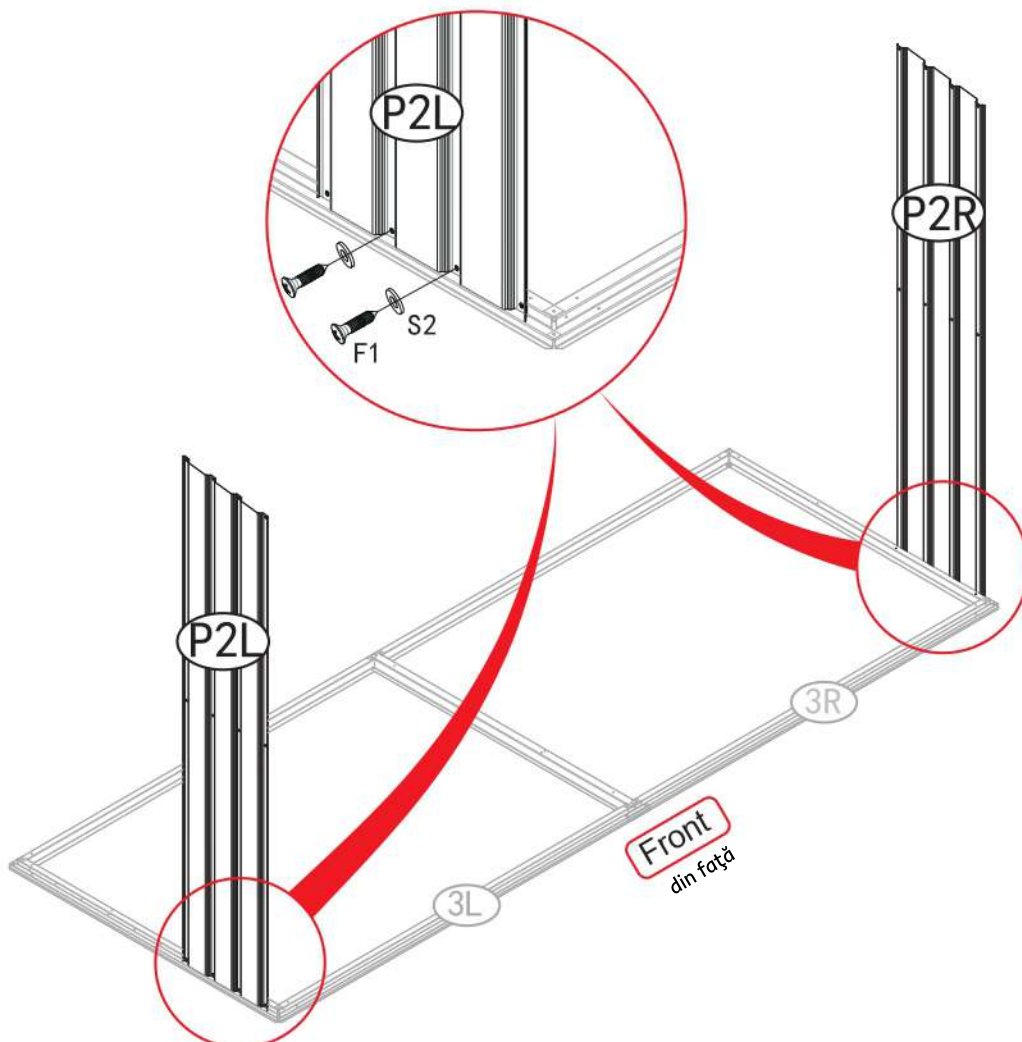
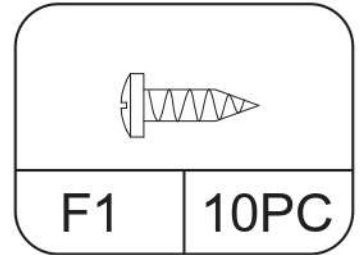
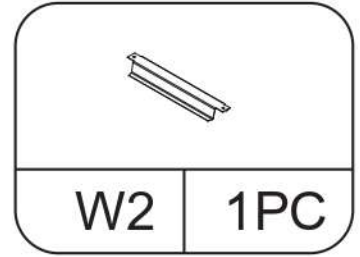
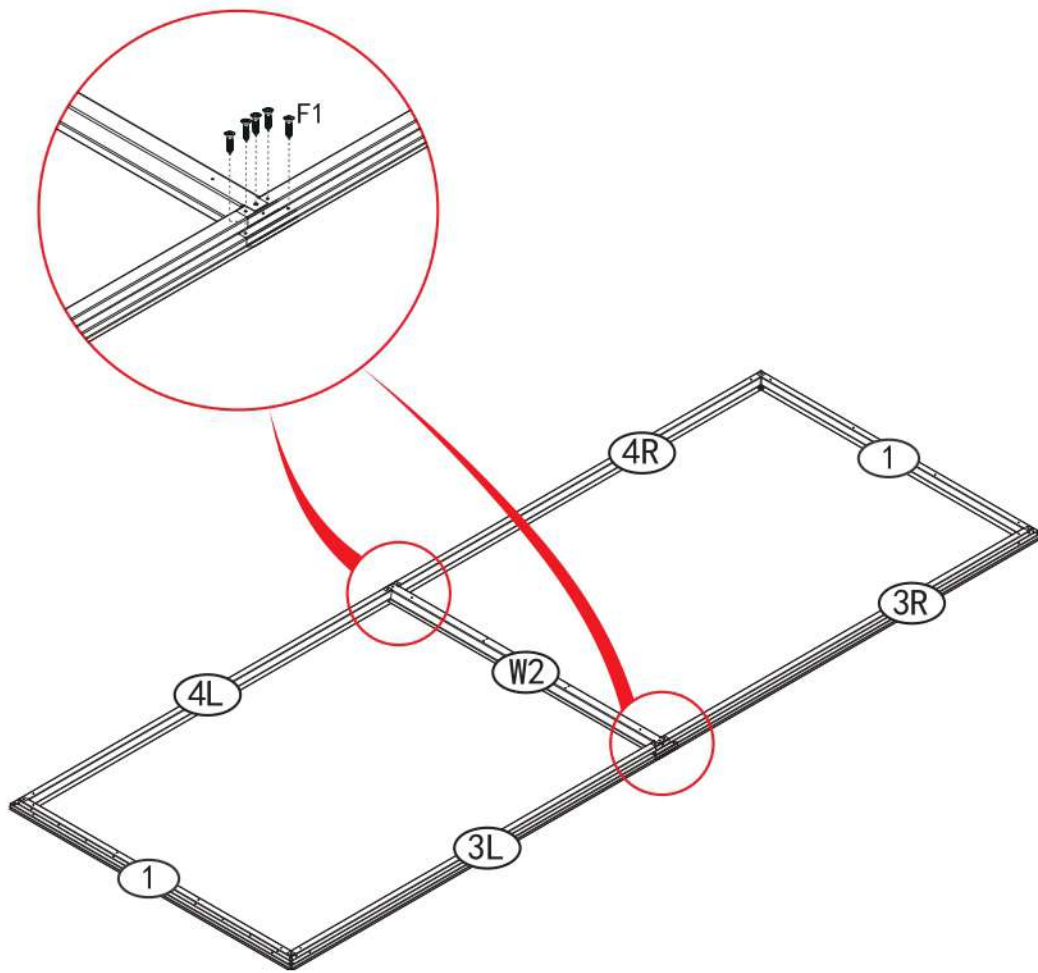

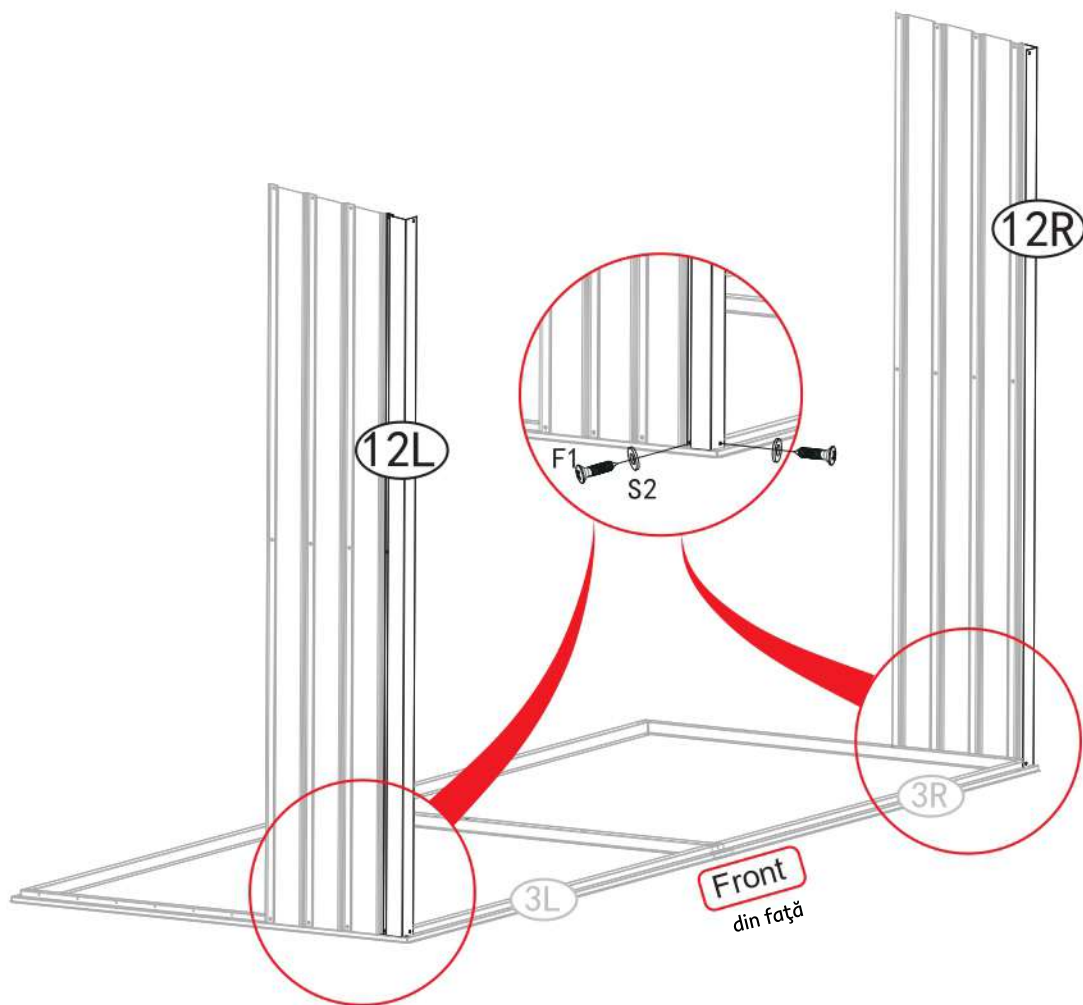

12L	1PC

12R	1PC

F1	4PC

S2	4PC

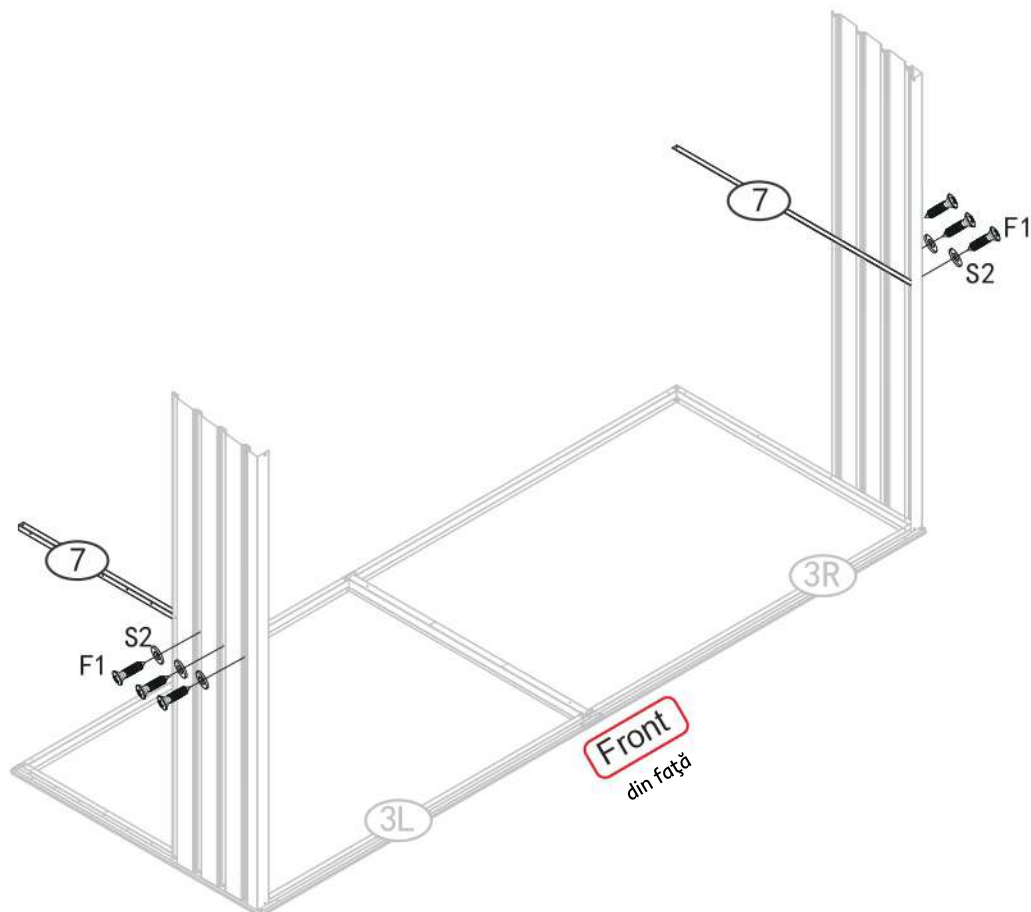

7	2PC

F1	6PC

S2	6PC

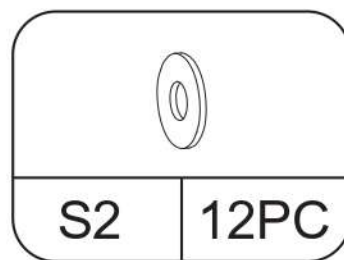
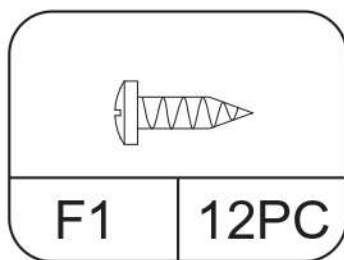
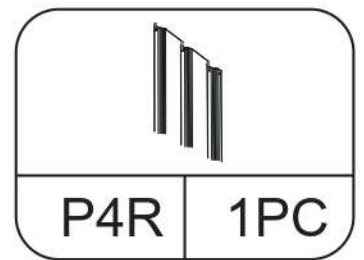
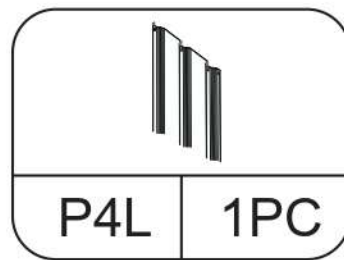
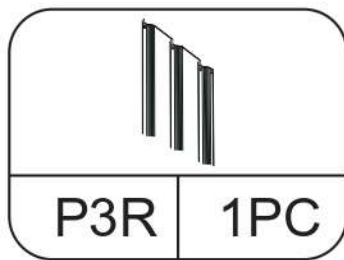
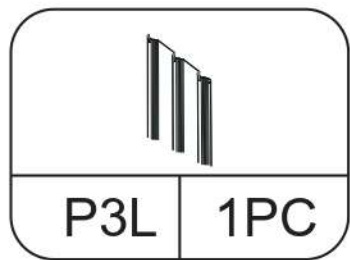
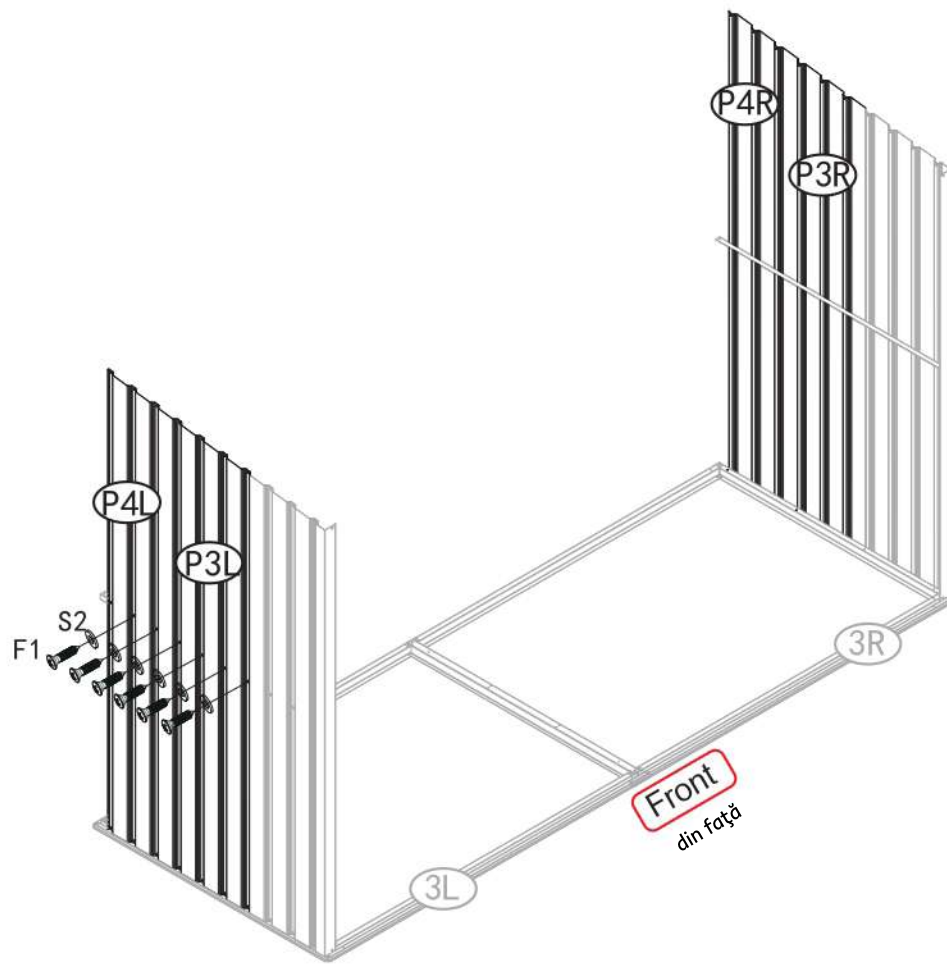



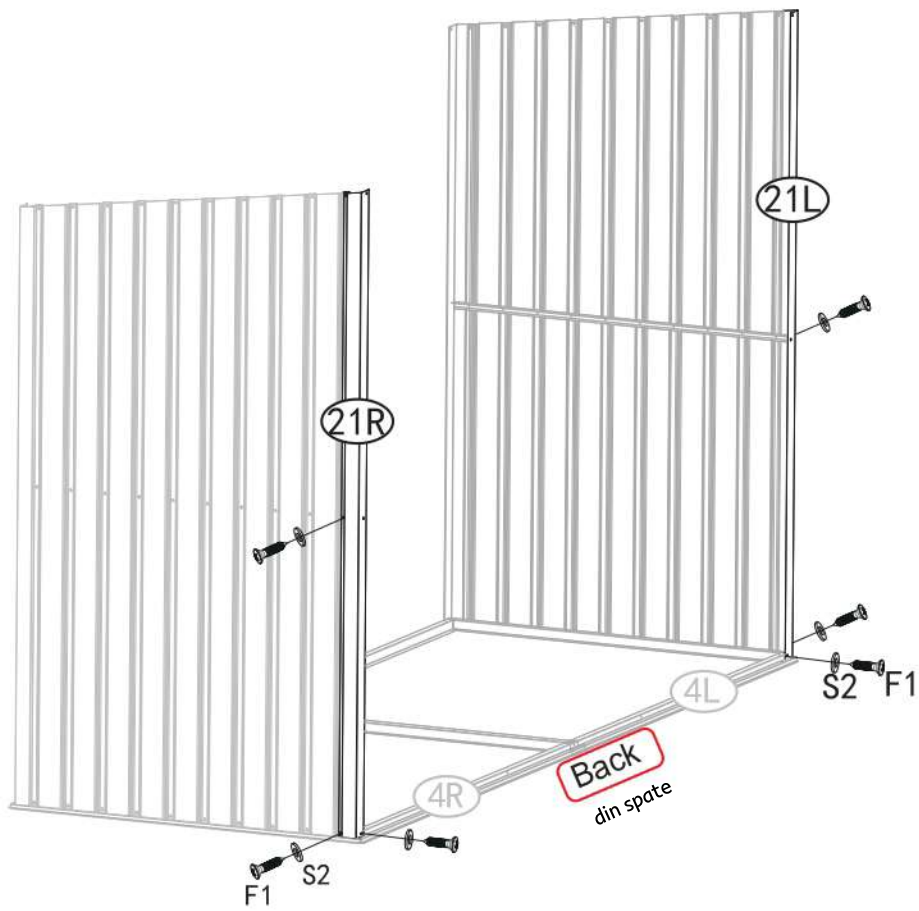

21L	2PC

21R	1PC

F1	6PC

S2	6PC

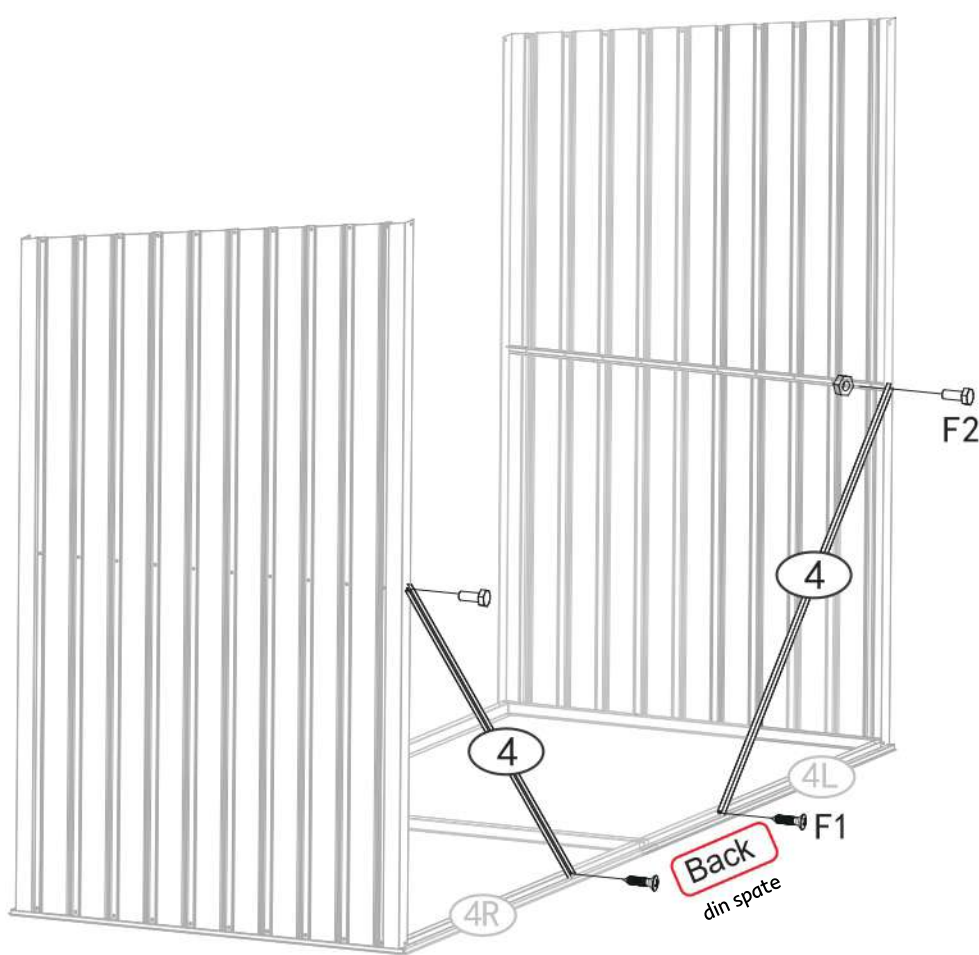

7	2PC

F2	2PC

F1	2PC

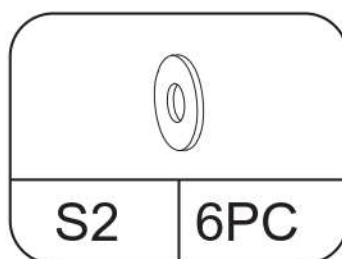
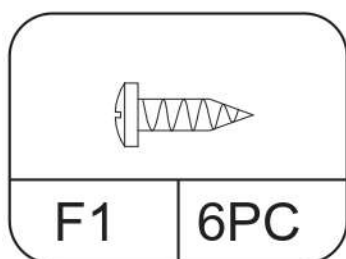
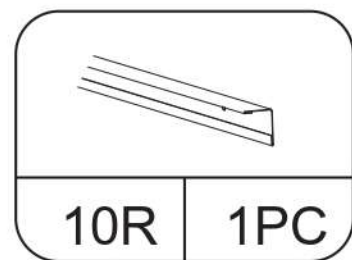
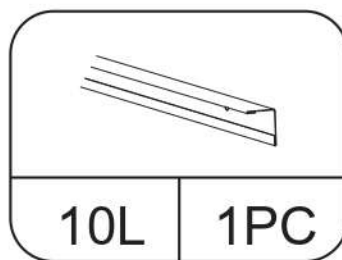
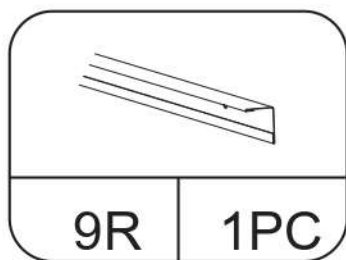
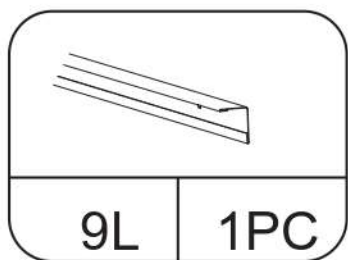
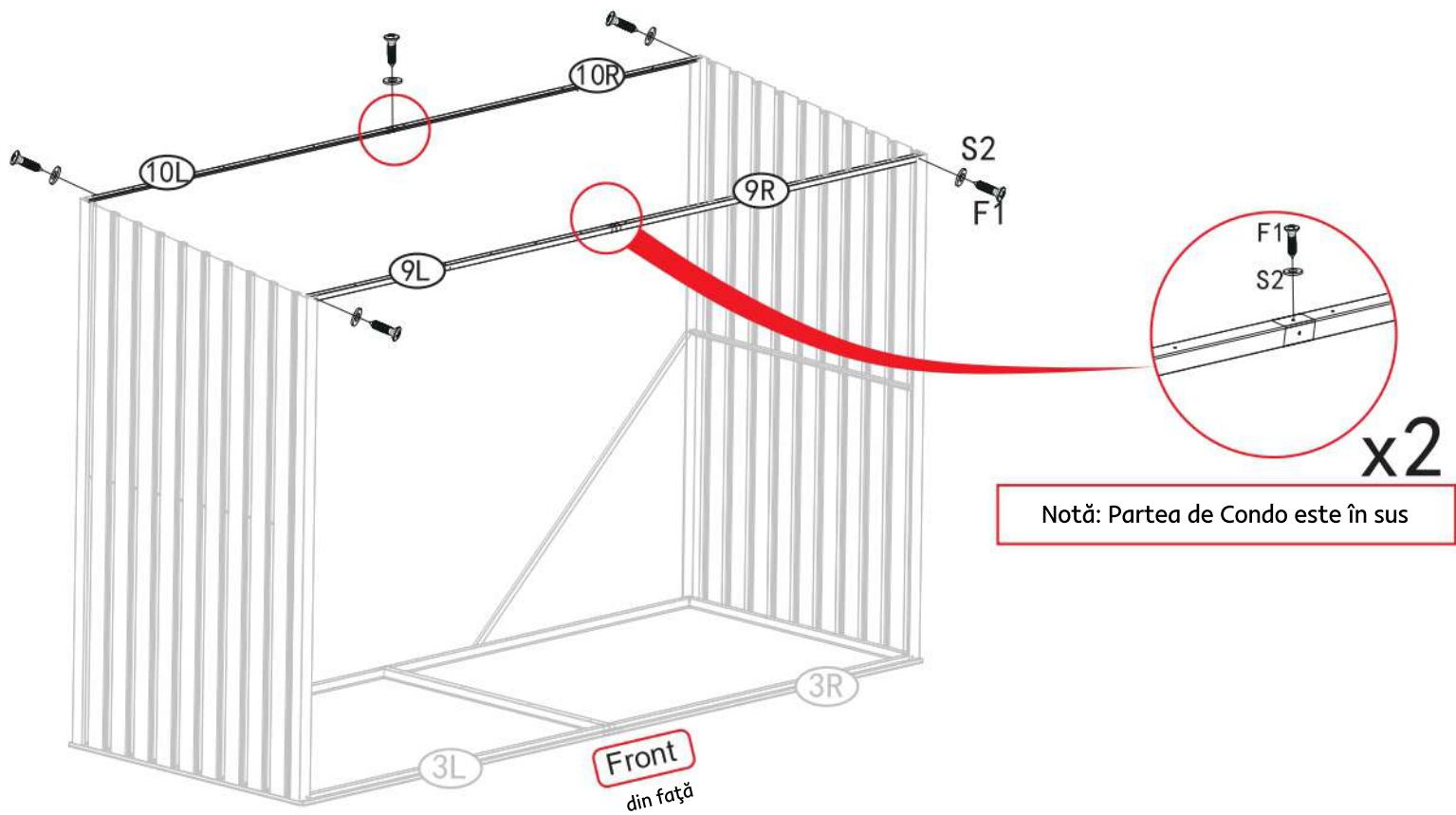

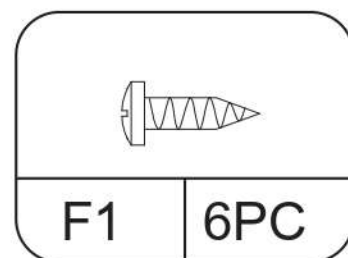
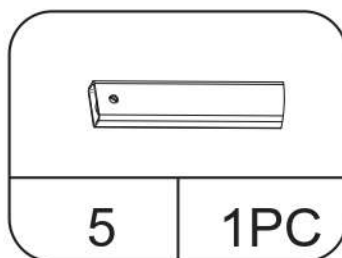
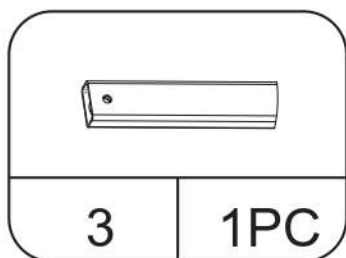
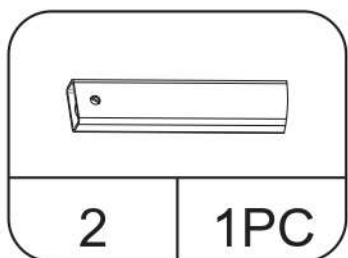
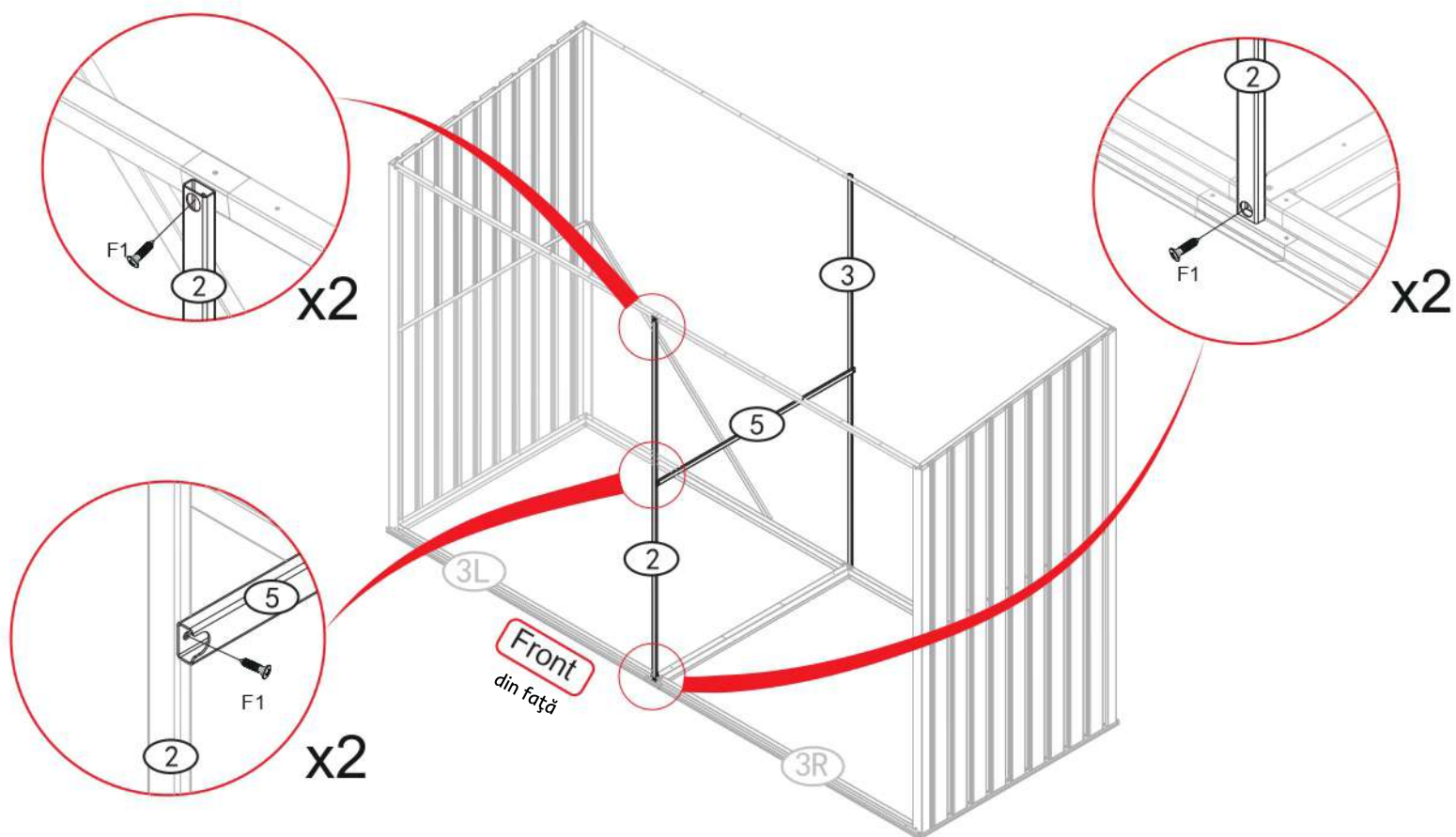
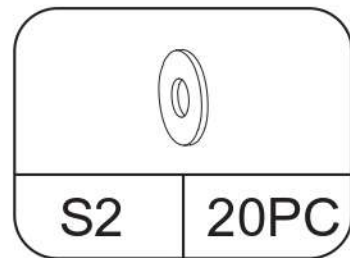
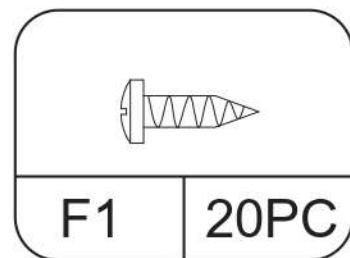
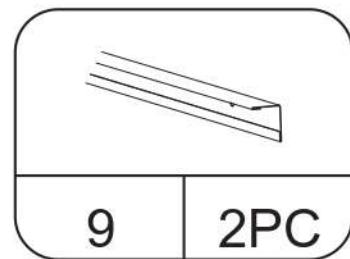
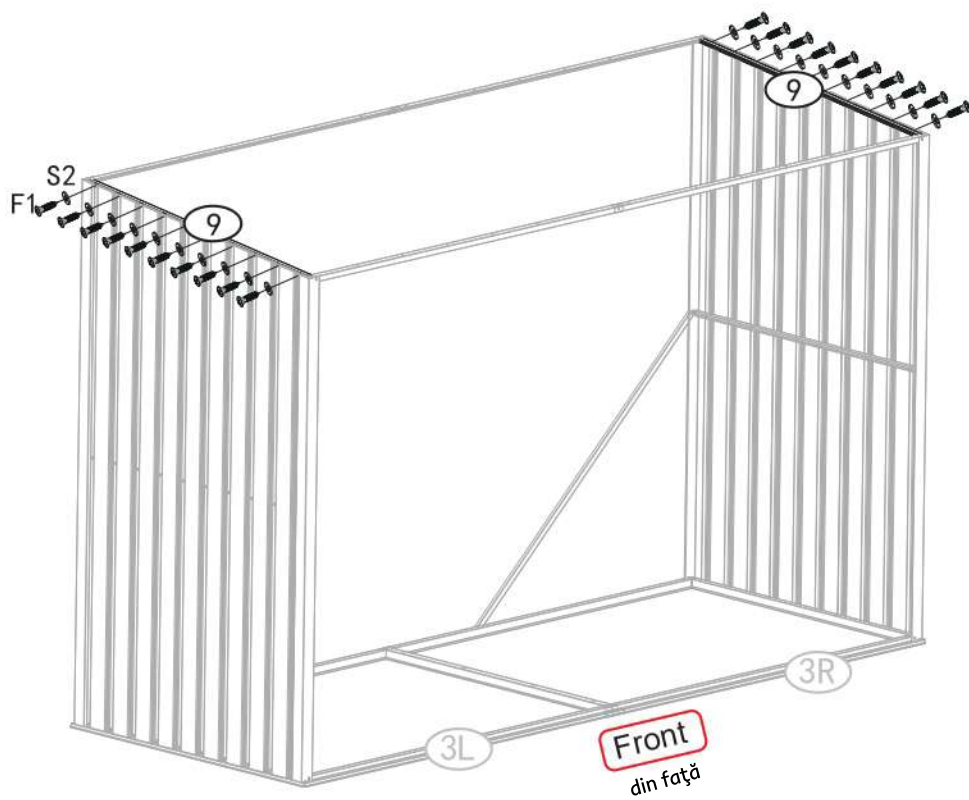

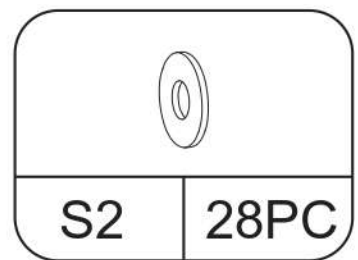
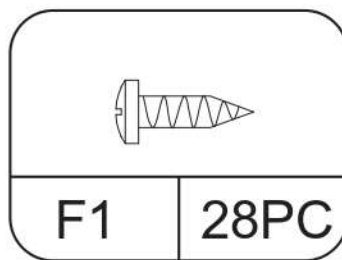
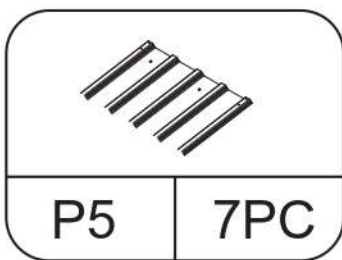
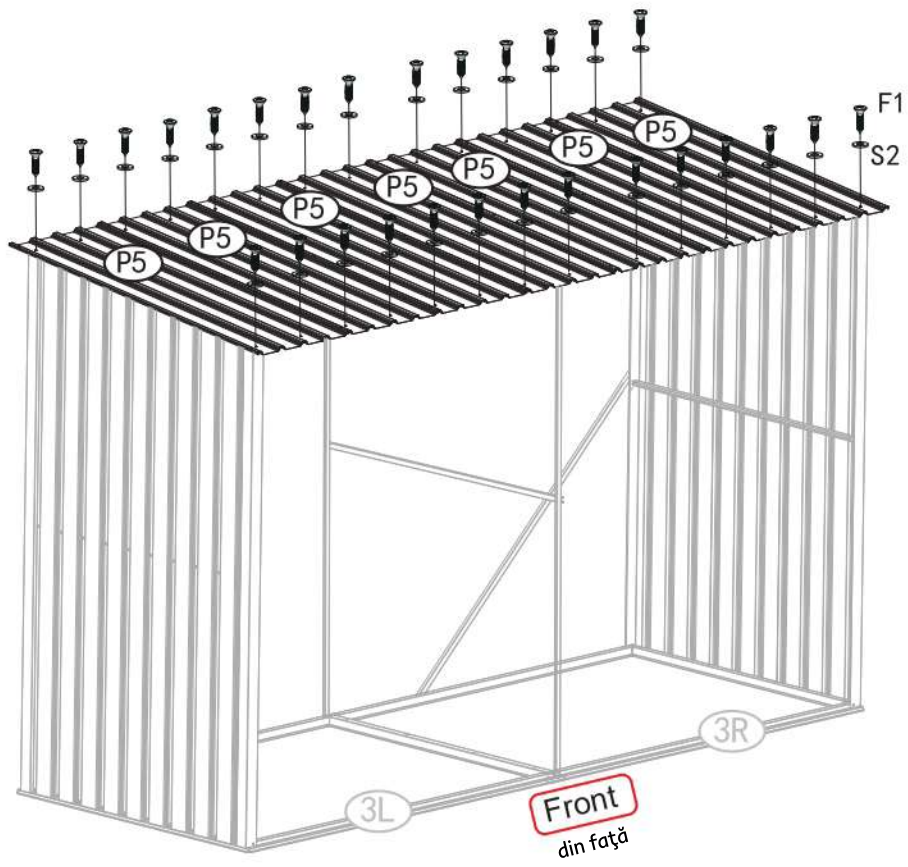

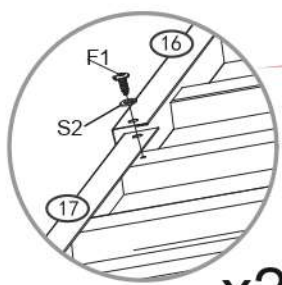

x2

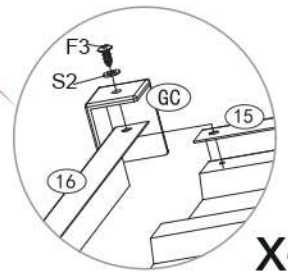

x4

